

*minimal training
required*

BELDOS

low investment

FOR A BETTER FILLING

Mini-fill Injecting & Filling Machine

Invest less and get more out of the Mini-fill!

Do you need a compact affordable machine for precise portion control, injection, layering and decoration?

Do you need a flexible and custom made solution for bakeries, catering or food service? Do you need to produce a large variety of products with minimum change over and cleaning?

You are in the right place! We are looking forward to hearing from you and supporting you with the best expertise!

Design features:

- compact injecting & filling machine for **DEPOSITING | INJECTION | LAYERING | DECORATION**
- **ELECTRIC OR ELECTRO-PNEUMATIC** versions depending on the product viscosity
- easy-to-use color **TOUCH SCREEN**
 - single/automatic or continuous mode
 - volume
 - speed
 - waiting time between deposits
 - number of automatic deposits
 - reverse mode to prevent dripping



*save ingredients
by correct dosing*

- you can **STORE UP TO 100 PRODUCTS IN THE MENU** with their corresponding dosing settings



- the **MENU** is available in the following **LANGUAGES**: English, Dutch, French, German, Spanish, Russian, Chinese, Swedish

- **QUICK INTERCHANGEABLE ALL-IN-ONE HOPPERS**



CLICK HERE TO WATCH
THE MOVIE

 - 8°
cold products

APPLICATIONS

sweet & savoury
products

+120° 
hot products



DEPOSITING



depositing of cake batter, muffins, jam, jelly, fruit filling, cream, mousse, meringue, ice-cream, yoghurt, soup, sauce, mashed potatoes, minced meat, salad, etc.



INJECTION



injection of éclairs, Berliners, croissants & donuts, etc.



LAYERING

layering of custard, fruit fillings, mousse, sauces, etc.



OPTIONS

FILLER UNITS & ATTACHMENTS



cooling jacket



3 L



8 L



15 L



single outlet



double outlet



synthetic follower plate



st. steel follower plate



hopper division



heater jacket

quick product change

SPOUTS for electric or electro-pneumatic power base

multi-functional



spout 90 °



electric handgun spout



injection spouts



plain spouts



cream cover head spout



layering spout



multi spout



injection spout for donuts



injection spout for croissants

SPOUTS

ONLY for electro-pneumatic power base



pneumatic handgun spout



pneumatic vertical spout

SEE A COMPLETE OVERVIEW OF THE OPTIONS IN THE CATALOGUE

COMMANDS



hand switch suitable both for left and right-handed people



handgun with a trigger



foot pedal

FILLER UNITS

double outlet



3 l



8 l



15 l

GEAR ASSEMBLY

double outlet

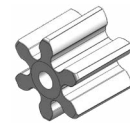
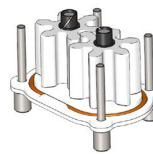

6 teeth



VISCOSITIES

from soft till semi-heavy products

PARTICLE SIZE, MM

ONLY particles such as seeds

FILLER UNITS

single outlet



3 l



8 l



15 l

GEAR ASSEMBLIES

single outlet

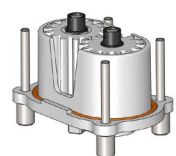
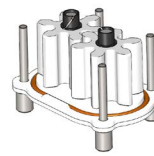
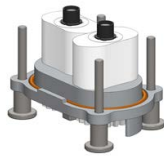
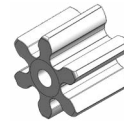
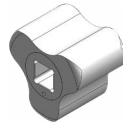
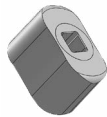

2 lobe

3 lobe

6 teeth

14 teeth

VISCOSITIES

from soft till heavy and aerated products

from soft till heavy and aerated products

from soft till semi-heavy products

ONLY semi-liquid products

PARTICLE SIZE, MM

soft and hard particles max d 15 mm

soft and hard particles max d 10 mm

soft and hard particles max d 5 mm

ONLY particles such as seeds



*fast, accurate,
clean & easy dosing*

SPECIFICATION

*tool-free
assembly*

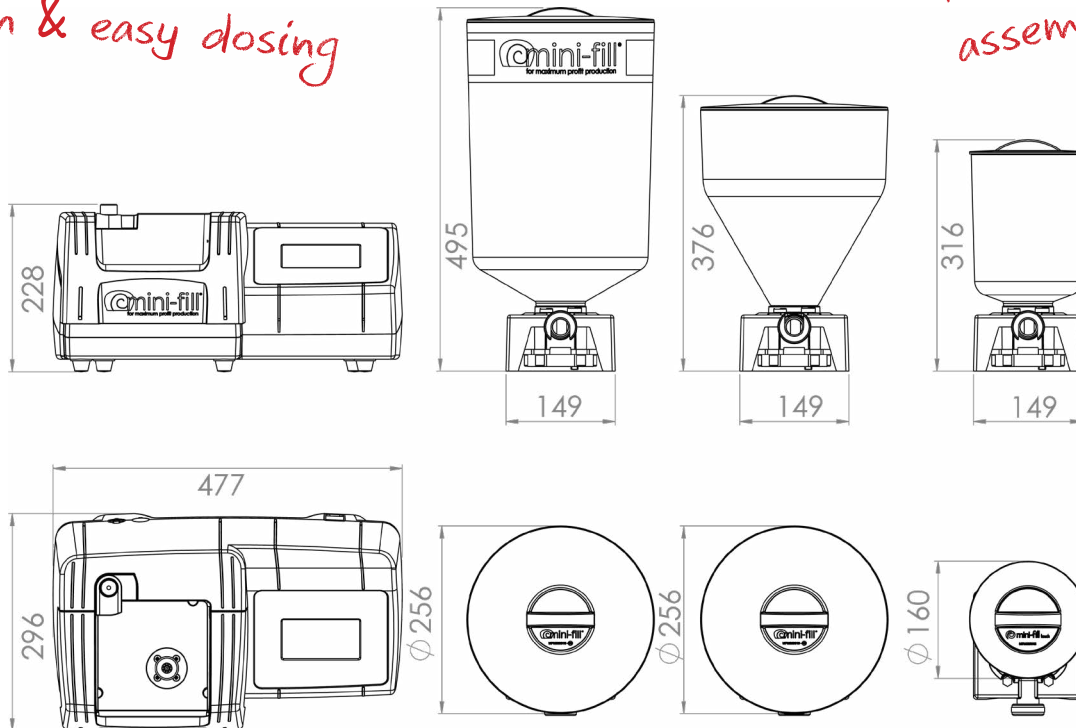

	Mini-fill Electric 100 W	Mini-fill Electric 260 W	Mini-fill Electro- pneumatic 260 W
POWER	110/220 V 50/60 Hz 100 W	110/220 V 50/60 Hz 260 W	110/220 V 50/60 Hz, 260 W 6 Bar compressed air
COMPRESSOR	-	-	1,5 kW - 8 bar 24 l - 196 l/min
SPEED	up to 50 deposits/min		
DEPOSIT RANGE	3-5000 ml		
VISCOSITIES	soft, aerated products	soft, heavy, aerated products	DRIP-FREE DOSING semi-liquid, soft, heavy, aerated products
PRODUCTS	custard, marmalade, fruit filling, cheese filling, mayonnaise, mousse, whipped cream	custard, marmalade, fruit filling, cheese filling, mayonnaise, sauce, mousse, whipped cream Nutella, muffin batter, ice-cream, mashed potatoes, salads	custard, marmalade, fruit filling, cheese filling, mayonnaise, sauce, mousse whipped cream, Nutella, muffin batter, ice-cream, mashed potatoes, salads, milk rice, yoghurt choux paste

**THE PRODUCTS PER POWER BASE TYPE ARE GIVEN ONLY FOR A GENERAL REFERENCE.
PLEASE CONTACT OUR SALES TEAM FOR MORE INFORMATION!**



Beldos N.V.
Industrielaan 10 +32 3 646 40 48
2950 Kapellen info@beldos.be
Antwerp province www.beldos.com
Belgium

